

## AFDD RCBO 6kA 1P+N B CURVE 32A 30mA TYPE A

- Single module AFDD combined RCBO
- Double pole with switched neutral
- 32A, B-curve (MCB)
- 30mA Type A (RCD)
- Fault trip indicator (LED)



### General information

Standards	BS EN IEC 62606 BS EN IEC 61009-1
Width in number of modular spacing	1
Design of pole	1P+N
Number of protected poles	1
Neutral can be switched	Yes
Position of neutral terminal	Left
Trip unit technology	Thermal-magnetic
Tripping characteristic	Type B
Rated current ( $I_n$ ) [ A ]	32
Residual current-detection principle	Electronic (voltage dependent)
Type of residual current	Type A
Residual current protection time delay	General type without time delay
Rated residual operating current ( $I_{\Delta n}$ ) [ mA ]	30
<b>Breaking capacity</b>	
Rated ultimate short-circuit breaking capacity ( $I_{cn}$ ) [ kA ]	6
Rated residual breaking and making capacity ( $I_{\Delta m}$ ) [ kA ]	2
Energy limiting class	3
Barcode (EAN-13)	5060690138648

### Technical information

Nature of power supply	AC
Rated operational voltage ( $U_e$ ) [ V ]	240 (230)
Rated frequency ( $f$ ) [ Hz ]	50
Rated insulation voltage ( $U_i$ ) [ V ]	500
Rated impulse withstand voltage ( $U_{imp}$ ) [ kV ]	4
Fault trip indicator	LED
Contact position indication	Green/Red windows
<b>Endurance</b>	

### Danson Electrical UK Limited.

● Mechanical	[ ops. ]	10000
● Electrical	[ ops. ]	4000

## Environmental information

<b>Degree of protection</b>		
● Housing		IP40
● Terminals		IP20
Pollution degree		3
Overvoltage category		III
Altitude (maximum)	[ Meter ]	Max. 2000
<b>Ambient air temperature for operation</b>		
● Minimum	[ °C ]	-5
● Maximum	[ °C ]	+40
<b>Ambient air temperature for storage</b>		
● Minimum	[ °C ]	-25
● Maximum	[ °C ]	+55
Reference ambient air temperature		[ °C ] 30
Relative humidity		28 cycles with +20 °C/95% and +40 °C/50%

## Package information

<b>Package level 1</b>		
Type		Box
Number of units in package level 1	[ pcs ]	1
Weight	[ kg ]	190
Length	[ mm ]	130
Width	[ mm ]	33
Height	[ mm ]	93
<b>Package level 2</b>		
Type		Carton
Number of units in package level 2	[ pcs ]	108
Weight	[ kg ]	21.87
Length	[ mm ]	625
Width	[ mm ]	330
Height	[ mm ]	275
<b>Package level 3</b>		
Type		Pallet
Number of units in package level 3	[ pcs ]	2160
Weight	[ kg ]	465
Length	[ mm ]	1200
Width	[ mm ]	1000
Height	[ mm ]	1250

## Mounting & Connection

Mounting position	Any
-------------------	-----

Mounting method	on DIN rail EN 60715 (35 mm) by means of clip	
Power supply from	Bottom terminal	
Terminal type		
<b>Bottom</b>		
● Line live terminal	Screw terminals	
<b>Top</b>		
● Load live terminal	Screw terminals	
● Load neutral terminal	Screw terminals	
● Line neutral terminal	Flying neutral lead	
- Section	[ mm <sup>2</sup> ]	4
- Length	[ mm ]	600
- Colour		Blue
Function earth cable	No	
Colour of function earth cable	-	
Recommended screw driver	Pozidriv 2	
<b>Connection capacity</b>		
<b>Line live terminal</b>		
● Flexible/Stranded		
- Minimum	[ mm <sup>2</sup> ]	1
- Maximum	[ mm <sup>2</sup> ]	25
● Solid		
- Minimum	[ mm <sup>2</sup> ]	1
- Maximum	[ mm <sup>2</sup> ]	35
<b>Load live &amp; neutral terminals</b>		
● Flexible/Stranded/Solid		
- Minimum	[ mm <sup>2</sup> ]	1
- Maximum	[ mm <sup>2</sup> ]	10
Wiring stripping length	[ mm ]	11.5
<b>Tightening torque</b>		
● Line live terminal	[ N.m ]	2.5
● Load live & neutral terminals	[ N.m ]	1.2
Sealable handle	Yes	

## Diagram

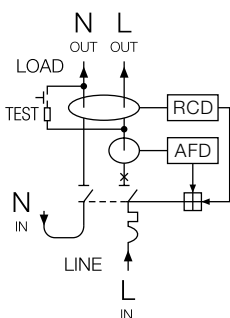

# E-AFDDY21325

## Dimensions

Height [ mm ]	Width [ mm ]	Depth [ mm ]	Weight [ g ]
116	17.8	76	180

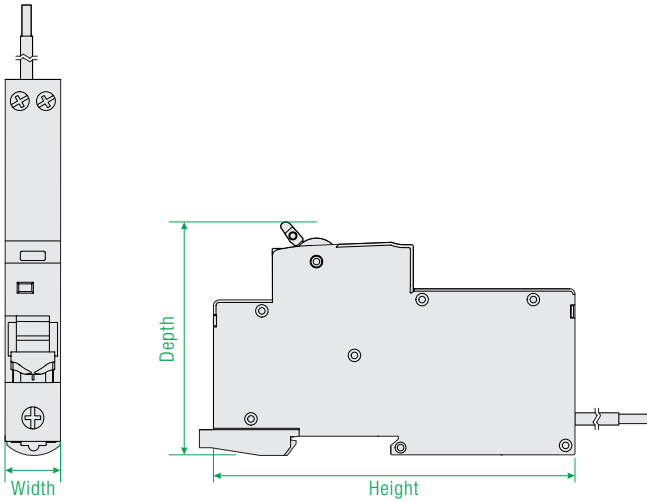

## Certificate

