

AFDD RCBO 6kA 1P+N C CURVE 6A 30mA TYPE A

- Single module AFDD combined RCBO
- Double pole with switched neutral
- 6A, C-curve (MCB)
- 30mA Type A (RCD)
- Fault trip indicator (LED)

General information

Standards	BS EN IEC 62606 BS EN IEC 61009-1
Width in number of modular spacing	1
Design of pole	1P+N
Number of protected poles	1
Neutral can be switched	Yes
Position of neutral terminal	Left
Trip unit technology	Thermal-magnetic
Tripping characteristic	Type C
Rated current (I_n) [A]	6
Residual current-detection principle	Electronic (voltage dependent)
Type of residual current	Type A
Residual current protection time delay	General type without time delay
Rated residual operating current ($I_{\Delta n}$) [mA]	30
Breaking capacity	
Rated ultimate short-circuit breaking capacity (I_{cn}) [kA]	6
Rated residual breaking and making capacity ($I_{\Delta m}$) [kA]	2
Energy limiting class	3
Barcode (EAN-13)	5060690139829

Technical information

Nature of power supply	AC
Rated operational voltage (U_e) [V]	240 (230)
Rated frequency (f) [Hz]	50
Rated insulation voltage (U_i) [V]	500
Rated impulse withstand voltage (U_{imp}) [kV]	4
Fault trip indicator	LED
Contact position indication	Green/Red windows
Endurance	

● Mechanical	[ops.]	10000
● Electrical	[ops.]	4000

Environmental information

Degree of protection		
● Housing		IP40
● Terminals		IP20
Pollution degree		3
Overvoltage category		III
Altitude (maximum)	[Meter]	Max. 2000
Ambient air temperature for operation		
● Minimum	[°C]	-5
● Maximum	[°C]	+40
Ambient air temperature for storage		
● Minimum	[°C]	-25
● Maximum	[°C]	+55
Reference ambient air temperature		[°C] 30
Relative humidity		28 cycles with +20 °C/95% and +40 °C/50%

Package information

Package level 1		
Type		Box
Number of units in package level 1	[pcs]	1
Weight	[kg]	190
Length	[mm]	130
Width	[mm]	33
Height	[mm]	93
Package level 2		
Type		Carton
Number of units in package level 2	[pcs]	108
Weight	[kg]	21.87
Length	[mm]	625
Width	[mm]	330
Height	[mm]	275
Package level 3		
Type		Pallet
Number of units in package level 3	[pcs]	2160
Weight	[kg]	465
Length	[mm]	1200
Width	[mm]	1000
Height	[mm]	1250

Mounting & Connection

Mounting position	Any
-------------------	-----

Mounting method	on DIN rail EN 60715 (35 mm) by means of clip	
Power supply from	Bottom terminal	
Terminal type		
Bottom		
● Line live terminal	Screw terminals	
Top		
● Load live terminal	Screw terminals	
● Load neutral terminal	Screw terminals	
● Line neutral terminal	Flying neutral lead	
- Section	[mm ²]	4
- Length	[mm]	600
- Colour	Blue	
Function earth cable	No	
Colour of function earth cable	-	
Recommended screw driver	Pozidriv 2	
Connection capacity		
Line live terminal		
● Flexible/Stranded		
- Minimum	[mm ²]	1
- Maximum	[mm ²]	25
● Solid		
- Minimum	[mm ²]	1
- Maximum	[mm ²]	35
Load live & neutral terminals		
● Flexible/Stranded/Solid		
- Minimum	[mm ²]	1
- Maximum	[mm ²]	10
Wiring stripping length	[mm]	11.5
Tightening torque		
● Line live terminal	[N.m]	2.5
● Load live & neutral terminals	[N.m]	1.2
Sealable handle	Yes	

Diagram

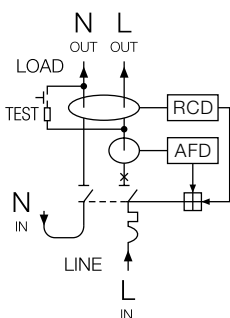

E-AFDDY41065

Dimensions

Height [mm]	Width [mm]	Depth [mm]	Weight [g]
116	17.8	76	180

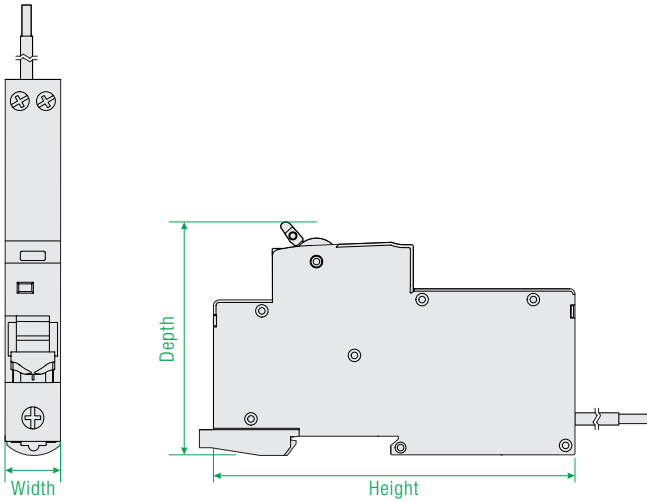

Certificate

