

## 2A MCB 10kA SP SINGLE MODULE B CURVE 230V AC

- Single pole MCB
- 2A B-curve
- 10kA, energy limiting class 3



### General information

Standards	BS EN 60898-1 IEC 60898-1
Width in number of modular spacing	1
Number of poles	1
Design of pole	1P
Number of protected poles	1
Neutral position	-
Neutral can be switched	-
Trip unit technology	Thermal-magnetic
Tripping characteristic	B
Rated current $I_n$ [A]	2
Breaking capacity	
Rated ultimate short-circuit breaking capacity $I_{cn}$ [kA]	10
Rated service short-circuit breaking capacity $I_{cs}$ [kA]	7.5
Energy limiting class	3
Suitability for isolation acc. to IEC/EN 60898-1	Yes
Barcode (EAN-13)	5060690139928

### Technical information

Type of current	AC
Rated operational voltage $U_e$ [V]	230/400
Frequency $f_n$ [Hz]	50/60
Rated insulation voltage $U_i$ [V]	500
Rated impulse withstand voltage $U_{imp}$ [kV]	4
Dielectric test voltage (50/60 Hz, 1 min.) [kV]	2
Contact position indication	Red ON / Green OFF
Endurance	
• Mechanical [ops.]	10000
• Electrical [ops.]	4000

### Environmental information

Degree of protection	IP20, with connected conductors
----------------------	---------------------------------

### Danson Electrical UK Limited.

Pollution degree		2
Overvoltage category		III
Altitude (maximum)	[ Meter ]	2000
Ambient air temperature for operation		
• Minimum	[ °C ]	-25
• Maximum	[ °C ]	+45
Ambient air temperature for storage		
• Minimum	[ °C ]	-30
• Maximum	[ °C ]	+60
Reference ambient air temperature	[ °C ]	30
Relative humidity		max. 95% at 55 °C

## Package information

Package 1		
Type		Box
Number of units in Package 1	[ pcs ]	12
Weight	[ kg ]	1.35
Length	[ cm ]	22.4
Width	[ cm ]	8.5
Height	[ cm ]	8
Package 2		
Type		Canton
Number of units in Package 2	[ pcs ]	240
Weight	[ kg ]	27.5
Length	[ cm ]	44.5
Width	[ cm ]	24
Height	[ cm ]	34
Package 3		
Type		Pallet
Number of units in Package 3	[ pcs ]	7200
Weight	[ kg ]	820
Length	[ cm ]	120
Width	[ cm ]	100
Height	[ cm ]	125

## Mounting & Connection

Mounting position		Any
Mounting on DIN rail acc. to IEC 60715		TH35-15, TH35-7.5
Terminal type		Screw terminals
Recommended screw driver		Pozidriv 2
<b>Connection capacity</b>		
<b>Solid and stranded</b>		
• Minimum	[ mm <sup>2</sup> ]	0.75
• Maximim	[ mm <sup>2</sup> ]	50

<b>Finely stranded with end sleeve</b>		
• Minimum	[ mm <sup>2</sup> ]	0.75
• Maximim	[ mm <sup>2</sup> ]	35
Wiring stripping length	[ mm ]	11.5
Tightening torque	[ N.m ]	2.5
Sealable handle		Yes
Accessories available		Yes

## Diagram



## Dimensions

Height [ mm ]	Width [ mm ]	Depth [ mm ]	Installation depth [ mm ]	Weight [ g ]
84	18	77	71	112

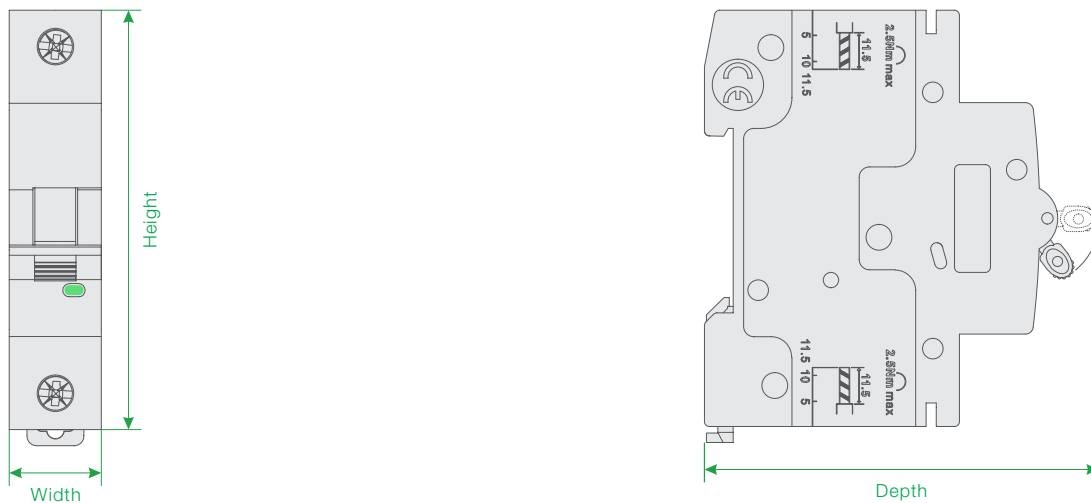

## Certificate

