

63A MCB 10kA TP THREE MODULE B CURVE 400V AC

- Triple pole MCB
- 63A B-curve
- 10kA, energy limiting class 3

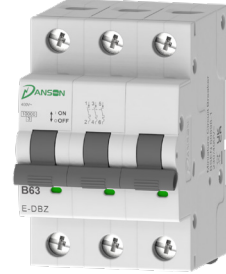

General information

Standards	BS EN 60898-1 IEC 60898-1
Width in number of modular spacing	3
Number of poles	3
Design of pole	3P
Number of protected poles	3
Neutral position	-
Neutral can be switched	-
Trip unit technology	Thermal-magnetic
Tripping characteristic	B
Rated current I_n [A]	63
Breaking capacity	
Rated ultimate short-circuit breaking capacity I_{cn} [kA]	10
Rated service short-circuit breaking capacity I_{cs} [kA]	7.5
Energy limiting class	3
Suitability for isolation acc. to IEC/EN 60898-1	Yes
Barcode (EAN-13)	5060690137979

Technical information

Type of current	AC
Rated operational voltage U_e [V]	400
Frequency f_n [Hz]	50/60
Rated insulation voltage U_i [V]	500
Rated impulse withstand voltage U_{imp} [kV]	4
Dielectric test voltage (50/60 Hz, 1 min.) [kV]	2
Contact position indication	Red ON / Green OFF
Endurance	
• Mechanical [ops.]	10000
• Electrical [ops.]	4000

Environmental information

Degree of protection	IP20, with connected conductors
----------------------	---------------------------------

Danson Electrical UK Limited.

Pollution degree		2
Overvoltage category		III
Altitude (maximum)	[Meter]	2000
Ambient air temperature for operation		
• Minimum	[°C]	-25
• Maximum	[°C]	+45
Ambient air temperature for storage		
• Minimum	[°C]	-30
• Maximum	[°C]	+60
Reference ambient air temperature	[°C]	30
Relative humidity		max. 95% at 55 °C

Package information

Package 1		
Type		Box
Number of units in Package 1	[pcs]	4
Weight	[kg]	1.35
Length	[cm]	22.4
Width	[cm]	8.5
Height	[cm]	8
Package 2		
Type		Canton
Number of units in Package 2	[pcs]	80
Weight	[kg]	27.5
Length	[cm]	44.5
Width	[cm]	24
Height	[cm]	34
Package 3		
Type		Pallet
Number of units in Package 3	[pcs]	2400
Weight	[kg]	820
Length	[cm]	120
Width	[cm]	100
Height	[cm]	125

Mounting & Connection

Mounting position		Any
Mounting on DIN rail acc. to IEC 60715		TH35-15, TH35-7.5
Terminal type		Screw terminals
Recommended screw driver		Pozidriv 2
Connection capacity		
Solid and stranded		
• Minimum	[mm ²]	0.75
• Maximim	[mm ²]	50

Finely stranded with end sleeve		
• Minimum	[mm ²]	0.75
• Maximim	[mm ²]	35
Wiring stripping length	[mm]	11.5
Tightening torque	[N.m]	2.5
Sealable handle		Yes
Accessories available		Yes

Diagram

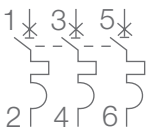

Dimensions

Height [mm]	Width [mm]	Depth [mm]	Installation depth [mm]	Weight [g]
84	54	77	71	336

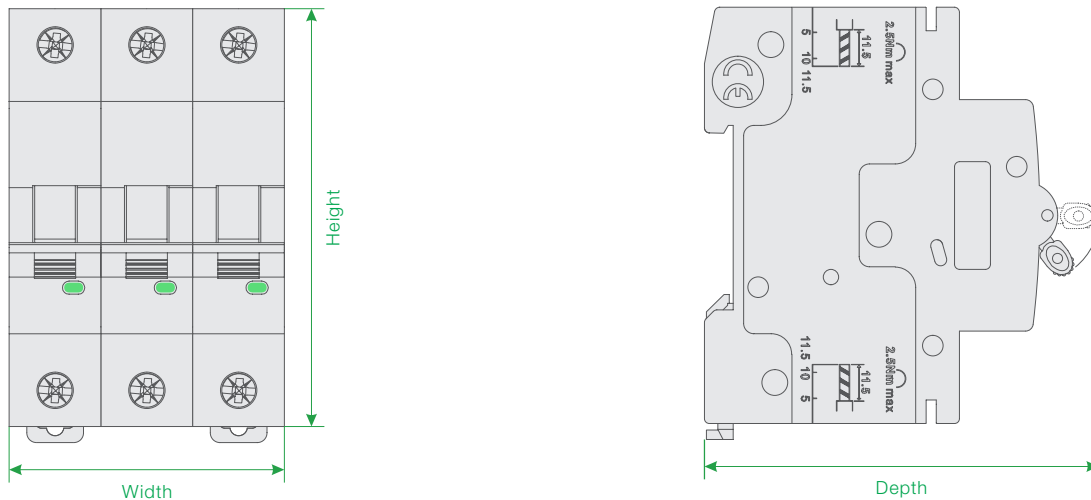

Certificate

