

RCBO 1M 1P+N 6kA C-curve 10A 30mA Type A

- Single module RCBO
- 1P+N
- 10A, C-curve
- 30mA, Type A
- Integrated functional earth cable



General information

Standards	BS EN 61009-1 IEC 61009-1 IEC 61009-2-2
Width in number of modular spacing	1
Design of pole	1P+N
Number of protected poles	1
Neutral can be switched	No
Trip unit technology	Thermal-magnetic
Tripping characteristic	C
Rated current I_n [A]	10
Residual current-detection principle	Electronic (voltage dependent)
Type of residual current	A type
Residual current protection time delay	General type without time-delay
Rated residual operating current $I_{\Delta n}$ [mA]	30
Breaking capacity	
Rated ultimate short-circuit breaking capacity I_{cn} [kA]	6
Rated residual breaking and making capacity $I_{\Delta m}$ [kA]	3
Barcode (EAN-13)	5060690132073

Technical information

Nature of power supply	AC
Rated operational voltage U_e [V]	230
Rated frequency f_n [Hz]	50
Rated insulation voltage U_i [V]	500
Rated impulse withstand voltage U_{imp} [kV]	4
Contact position indication	Red ON / Green OFF
Endurance	
• Mechanical [Cycle]	10000
• Electrical [Cycle]	4000

Mounting & Connection

Mounting position	Any
Mounting on DIN rail acc. to IEC 60715	TH35-15, TH35-7.5
Power supply connection	Bottom
Terminal type	
Bottom	
• Line live terminal	Screw terminals
Top	
• Load live terminal	Screw terminals
• Load neutral terminal	Screw terminals
• Line neutral terminal	Flying neutral lead
- Section [mm ²]	4
- Length [mm]	600
- Colour	Blue
Function earth cable	Yes
Colour of function earth cable	White
Recommended screw driver	Pozidriv 2
Connection capacity	
Solid / Stranded	
• Minimum [mm ²]	0.75
• Maximim [mm ²]	35
Finely stranded with end sleeve	
• Minimum [mm ²]	0.75
• Maximim [mm ²]	25
Wiring stripping length [mm]	11.5
Tightening torque [N.m]	2.5
Sealable handle	Yes

Environmental information

Degree of protection	IP20, with connected conductors
Pollution degree	2
Overvoltage category	III
Altitude (maximum) [Meter]	2000
Ambient air temperature for operation	
• Minimum [°C]	-5
• Maximum [°C]	+45
Ambient air temperature for storage	
• Minimum [°C]	-40
• Maximum [°C]	+70
Reference ambient air temperature [°C]	30
Relative humidity	max. 95% at 55 °C

Package information

Package level 1		
Type		Box
Number of units in Package 1	[pcs]	1
Weight	[kg]	0.2
Length	[cm]	15.7
Width	[cm]	3
Height	[cm]	8.5
Package level 2		
Type		Canton
Number of units in Package 2	[pcs]	120
Weight	[kg]	25
Length	[cm]	62.5
Width	[cm]	33
Height	[cm]	27.5
Package level 3		
Type		Pallet
Number of units in Package 3	[pcs]	2160
Weight	[kg]	465
Length	[cm]	120
Width	[cm]	100
Height	[cm]	125

Certificate



Diagram

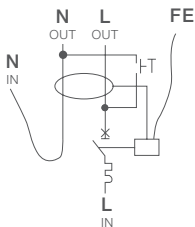

Dimensions

Height [mm]	Width [mm]	Depth [mm]	Installation depth [mm]	Weight [g]
126.5	18	77	71	200

E-DLY4110

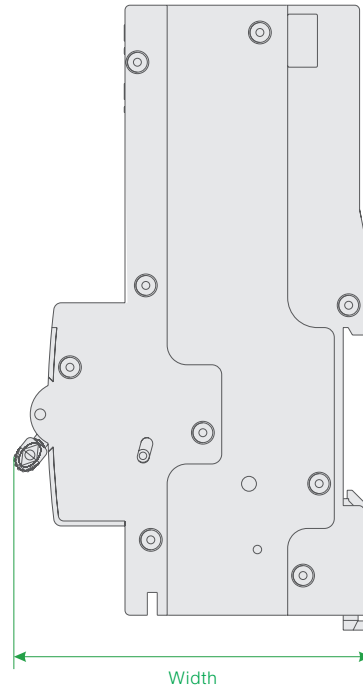
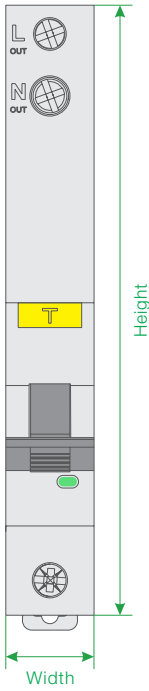

Danson Electrical UK Limited.