

Mini RCBO 1 Module 1P+N 6kA B Curve 10A Type A 30mA

- Single module mini RCBO
- Breaking capacity 6 kA
- 10A B-Curve
- 30mA, Type A
- The same height with switch-disconnector/MCB/RCCB



General information

Standards	BS EN IEC 61009-1 BS EN IEC 61009-2-2
Width in number of modular spacing	1
Design of pole	1P+N
Number of protected poles	1
Neutral can be switched	No
Position of neutral terminal	Right
Trip unit technology	Thermal-magnetic
Tripping characteristic	Type B
Rated current I_n [A]	10
Residual current-detection principle	Electronic (voltage dependent)
Type of residual current	Type A
Residual current protection time delay	General type without time delay
Rated residual operating current ($I_{\Delta n}$) [mA]	30
Breaking capacity	
Rated ultimate short-circuit breaking capacity (I_{cn}) [kA]	6
Rated residual breaking and making capacity ($I_{\Delta m}$) [kA]	2
Energy limiting class	3
Barcode (EAN-13)	5060690138846

Technical information

Nature of power supply	AC
Rated operational voltage (U_e) [V]	240 (230)
Rated frequency (f) [Hz]	50/60
Rated insulation voltage (U_i) [V]	500
Rated impulse withstand voltage (U_{imp}) [kV]	4
Contact position indication	Green/Red windows
Endurance	
• Mechanical [ops.]	20000

Danson Electrical UK Limited.

● Electrical	[ops.]	10000
--------------	----------	-------

Environmental information

Degree of protection		
● Housing		IP40
● Terminals		IP20
Pollution degree		
		3
Overvoltage category		
		III
Altitude (maximum)		[Meter]
		Max. 2000
Ambient air temperature for operation		
● Minimum	[°C]	-25
● Maximum	[°C]	+45
Ambient air temperature for storage		
● Minimum	[°C]	-40
● Maximum	[°C]	+70
Reference ambient air temperature		[°C]
		30
Relative humidity		
		28 cycles with +20 °C/95% and +40 °C/50%

Package information

Package level 1		
Type		Box
Number of units in package level 1		[pcs]
		1
Weight		[g]
		140
Length		[cm]
		11.2
Width		[cm]
		2.5
Height		[cm]
		8.2
Package level 2		
Type		Carton
Number of units in package level 2		[pcs]
		120
Weight		[kg]
		17.5
Length		[cm]
		43
Width		[cm]
		24
Height		[cm]
		34
Package level 3		
Type		Pallet
Number of units in package level 3		[pcs]
		3600
Weight		[kg]
		540
Length		[cm]
		120
Width		[cm]
		100
Height		[cm]
		125

Mounting & Connection

Mounting position		Any
Mounting method		on DIN rail EN 60715 (35 mm) by means of clip

Danson Electrical UK Limited.

Power supply connection	Bottom terminal
Terminal type	
Bottom	
● Line live terminal	Screw terminals
Top	
● Load live terminal	Screw terminals
● Load neutral terminal	Screw terminals
● Line neutral terminal	Flying neutral lead
- Section [mm ²]	4
- Length [mm]	600
- Colour	Blue
Function earth cable	No
Colour of function earth cable	-
Recommended screw driver	Pozidriv 2
Connection capacity	
Line live terminal	
● Flexible/Stranded	
- Minimum [mm ²]	1
- Maximum [mm ²]	25
● Solid	
- Minimum [mm ²]	1
- Maximum [mm ²]	35
Load live & neutral terminals	
● Flexible/Stranded/Solid	
- Minimum [mm ²]	1
- Maximum [mm ²]	10
Wiring stripping length [mm]	11.5
Tightening torque	
● Line live terminal [N.m]	2
● Load live & neutral terminals [N.m]	2.5
Sealable handle	Yes

Diagram

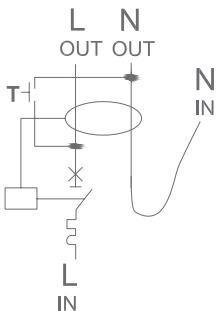

E-DLYM2110

Dimensions

Height [mm]	Width [mm]	Depth [mm]	Weight [g]
81	17.8	76.2	126

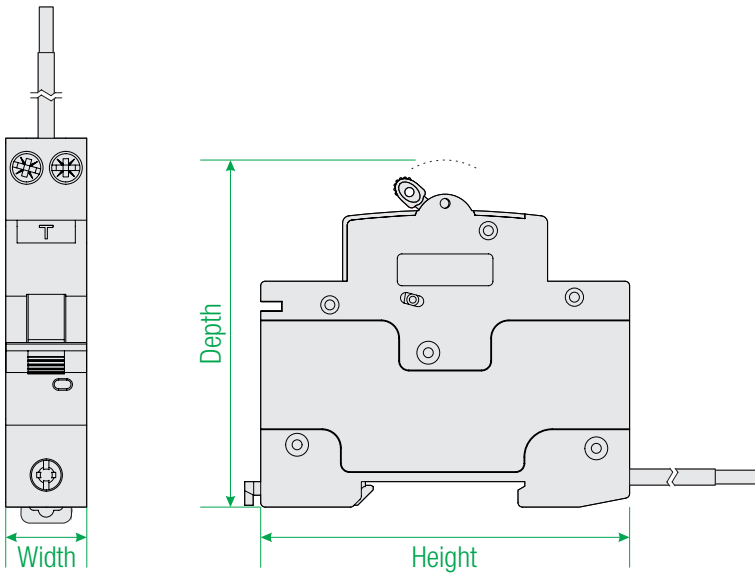

Certificate

**UK
CA**

CE

CB